

# DOMO 70RT

SISTEMA CORREDERA  
ROTURA DE PUENTE TÉRMICO



## CARACTERÍSTICAS

- Corredera corte recto.
- Rotura puente térmico en marcos.
- Perfiles en extrusión de aleación 6063.
- Espesor general 1.5 mm.
- Acrilamiento por medio de juntas de E.P.D.M.
- Anchura marco 207 mm.
- Anchura hoja 28 mm.

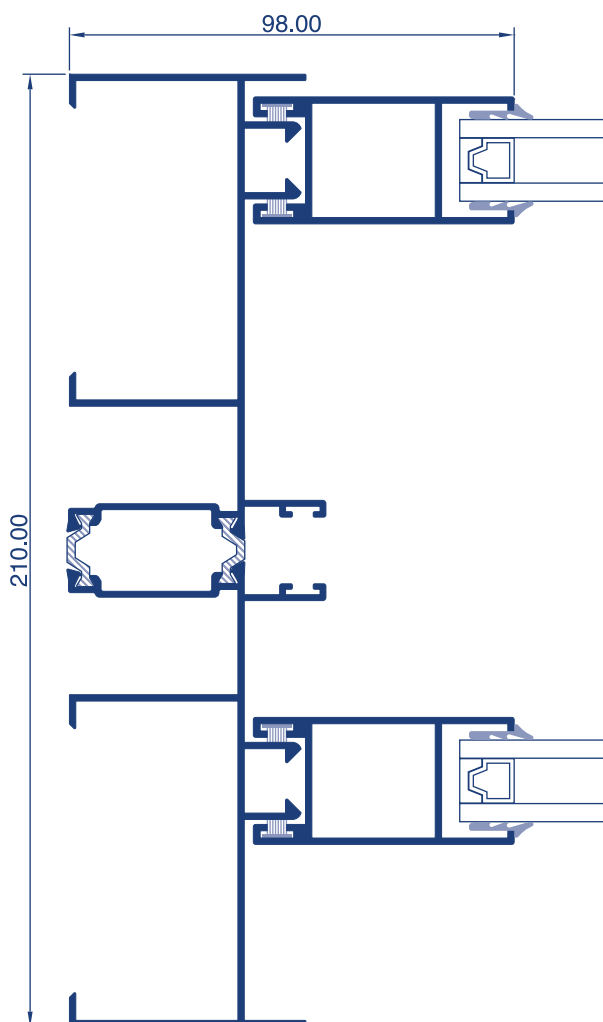

INDALSU 2011

EN 14351-1  
LGAI Technological Center, S.A.  
(APPLUS) Organismo Notificado N°0370

**Sistema DOMO 70RT**, ventana doble corredera de dos hojas y medidas  $\leq 2,7\text{m}^2$   
Acrilamiento 6/10/4 B.E.

Resistencia a la carga de viento	Clase C5
Permeabilidad al aire	Clase 3
Estanqueidad al agua	9A
Sustancias peligrosas	NPD
Capacidad de soporte de carga de los dispositivos de seguridad	
Prestaciones acústicas	49 (-2,-4)
Transmitancia térmica ( $U_w$ )	2,0 W/m <sup>2</sup> K

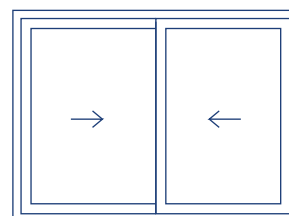

Corredera

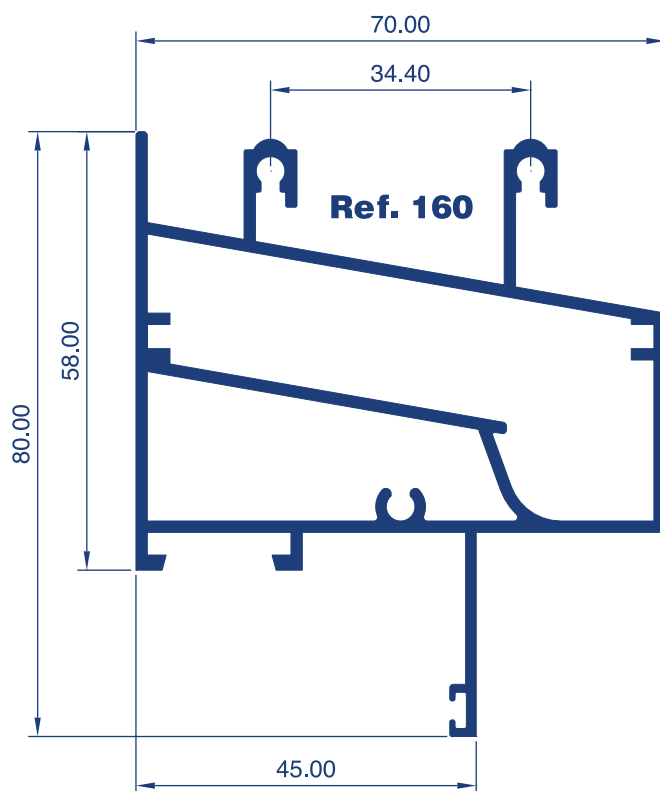
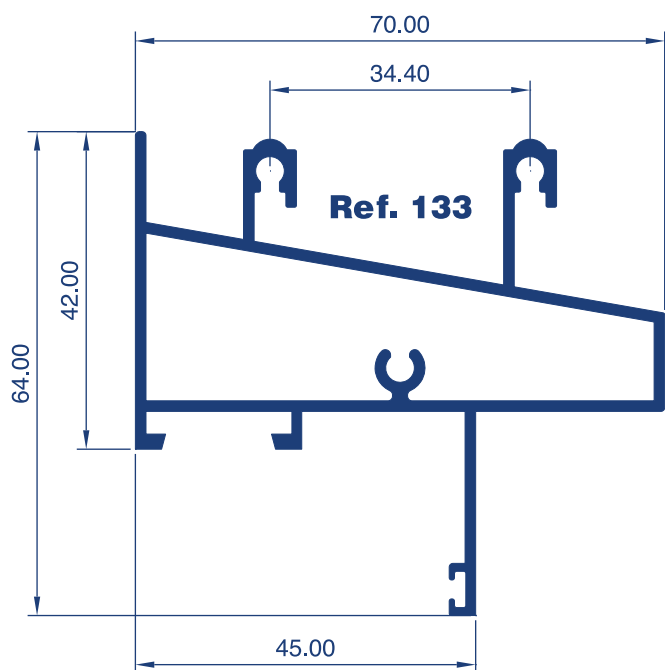
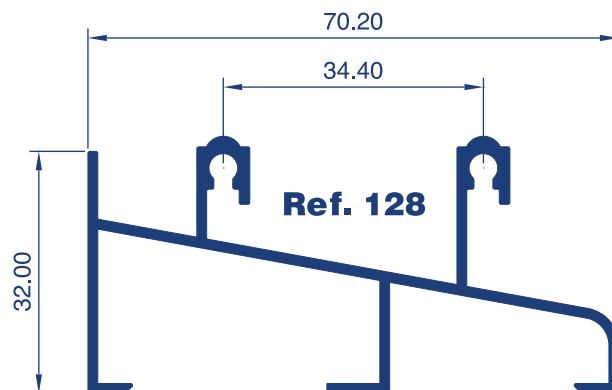
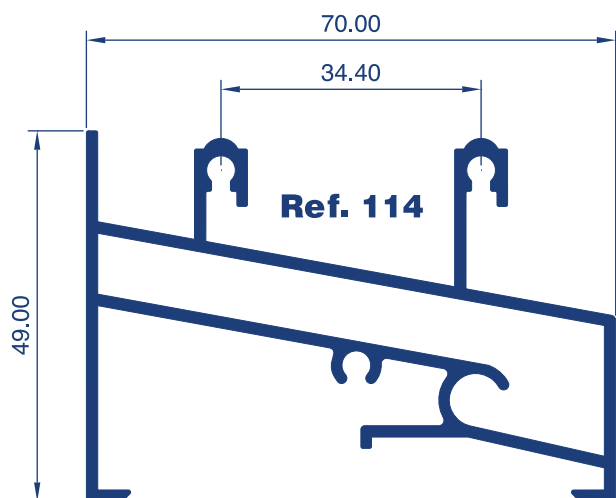

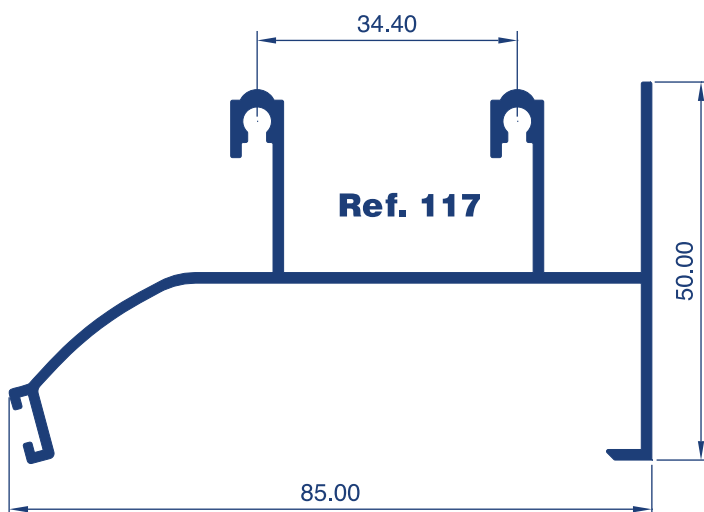
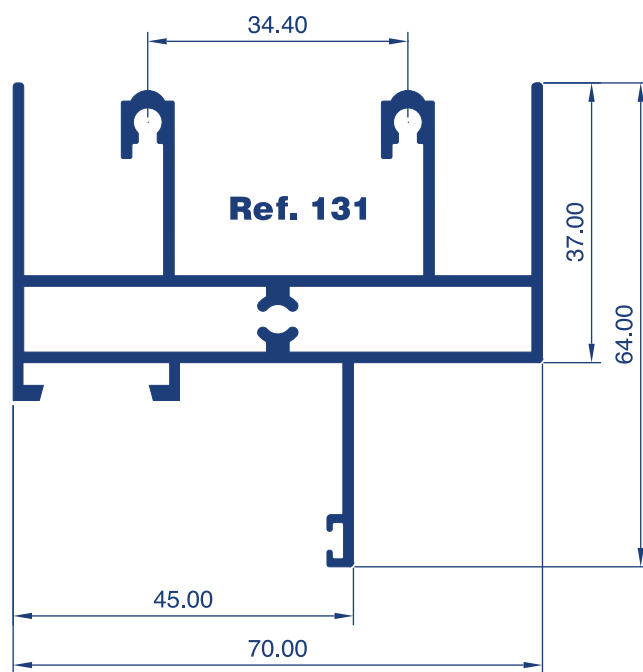
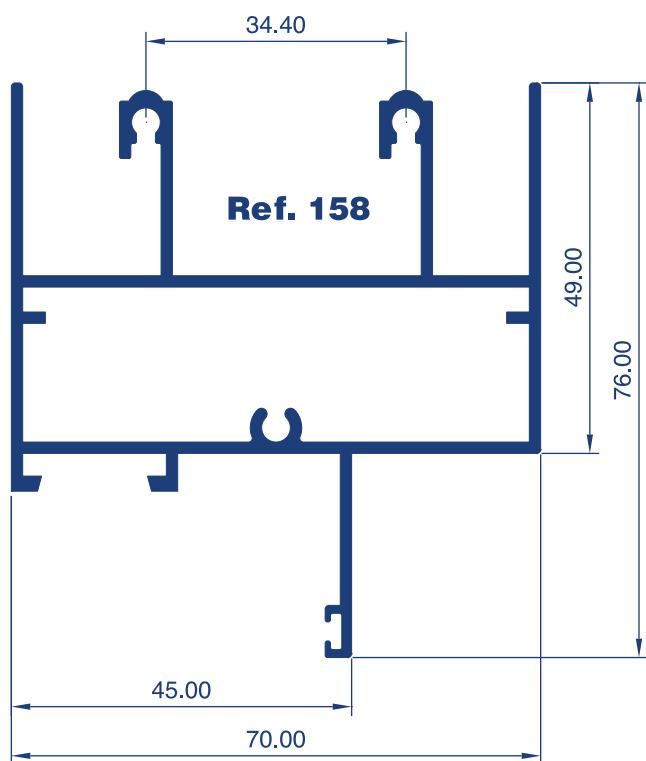
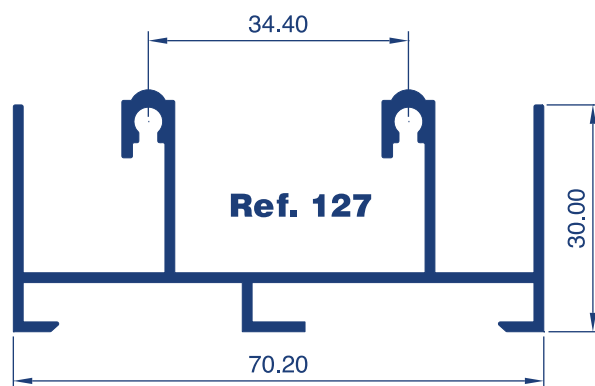
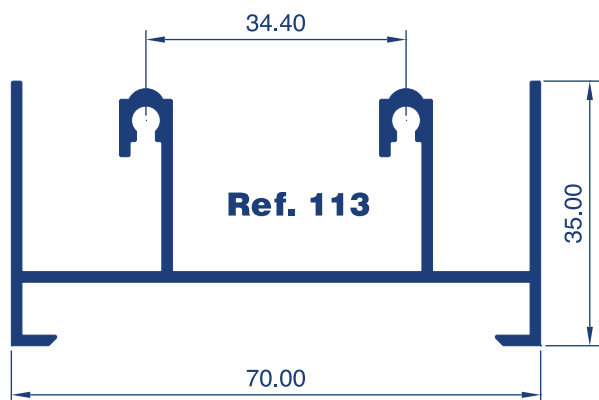

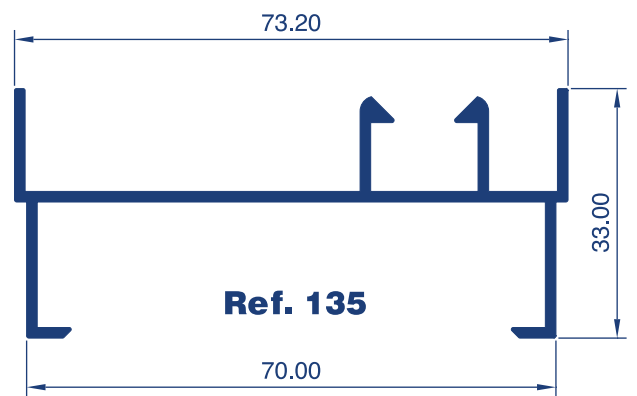
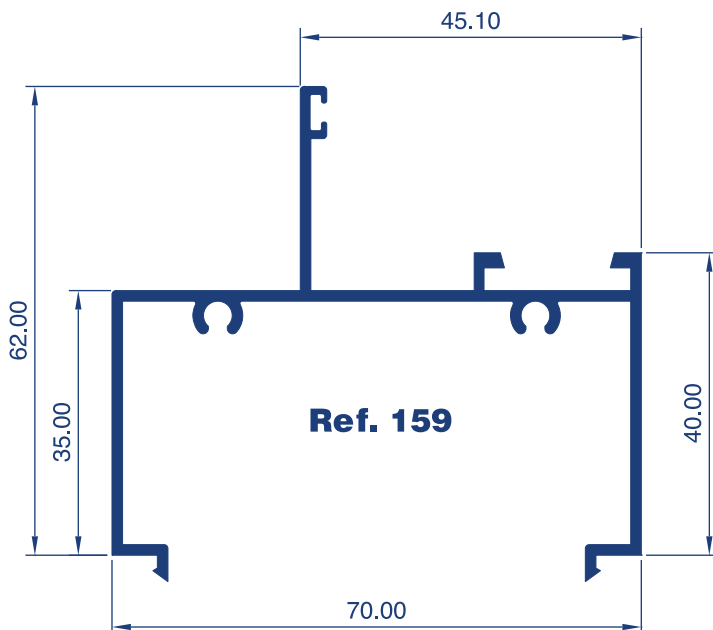
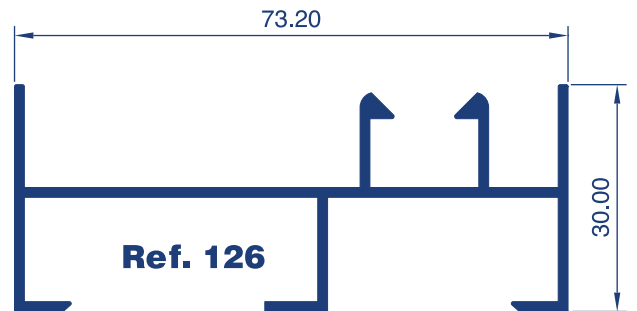
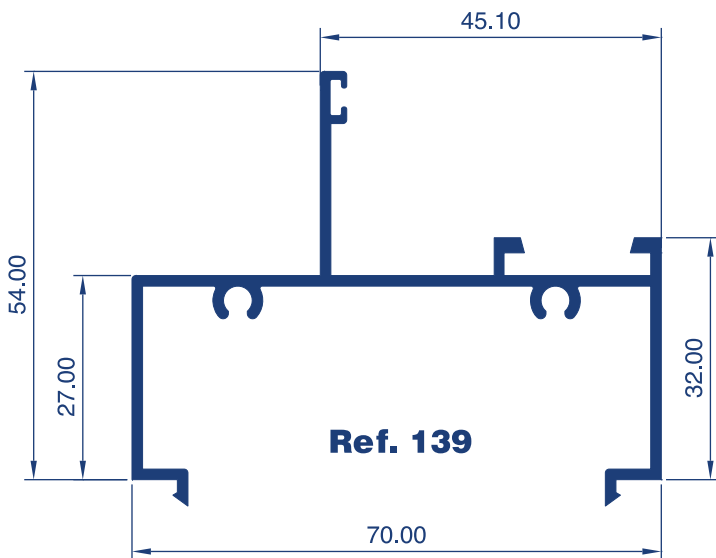
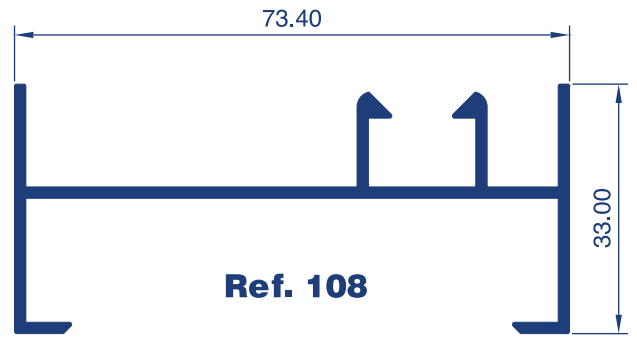
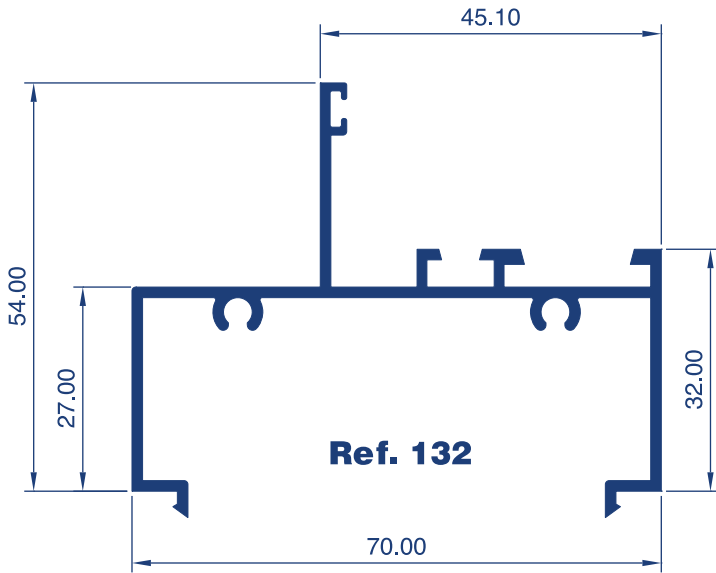

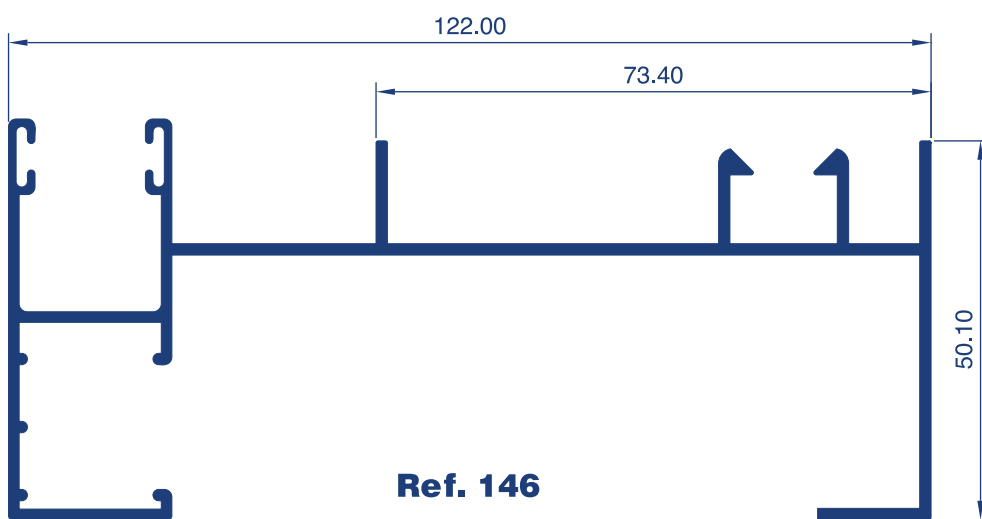
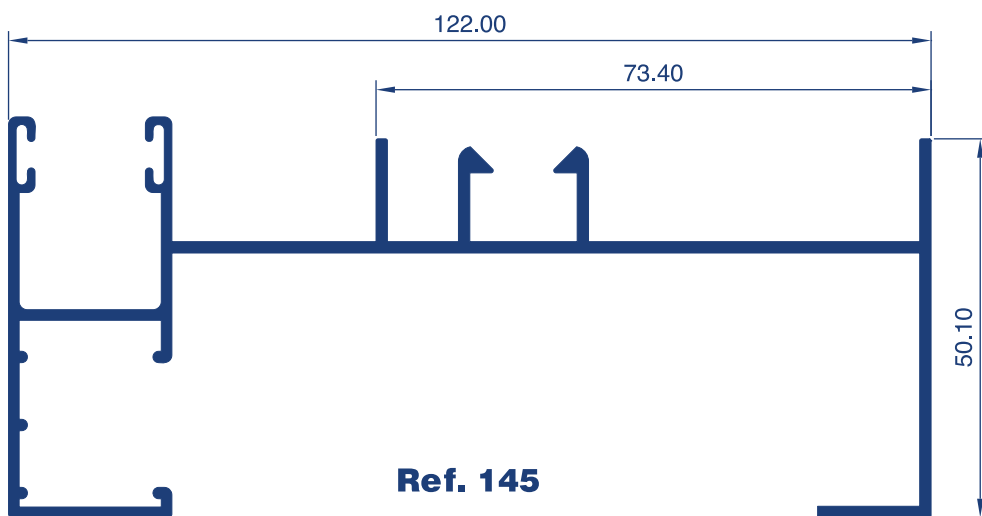

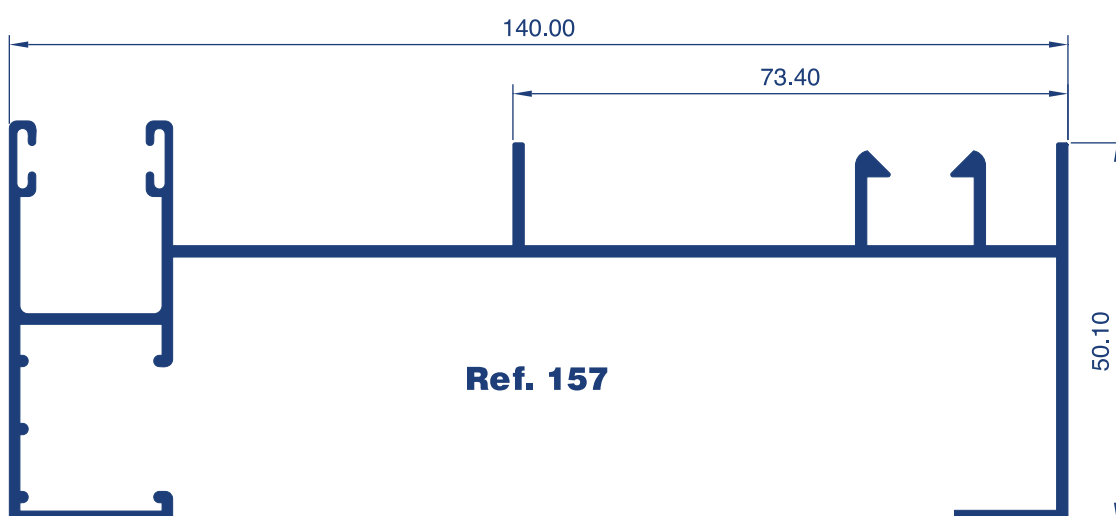
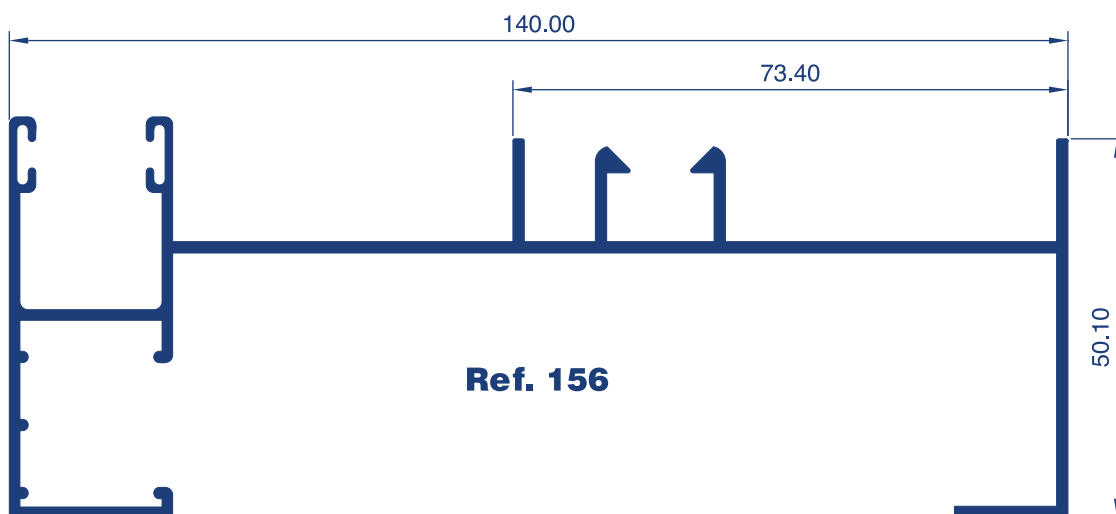

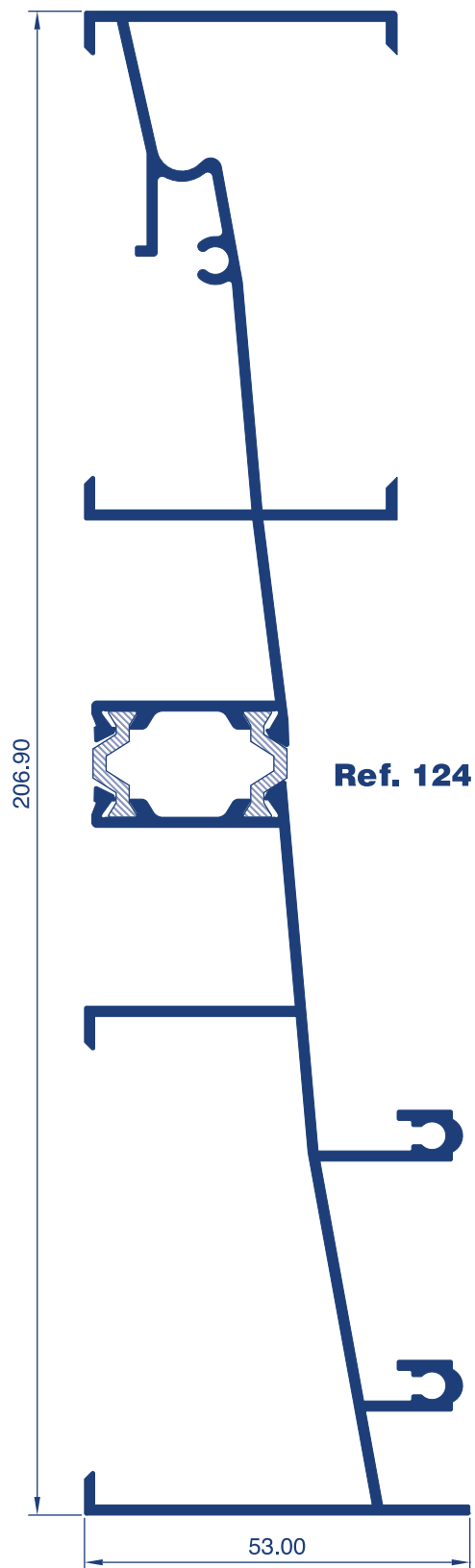
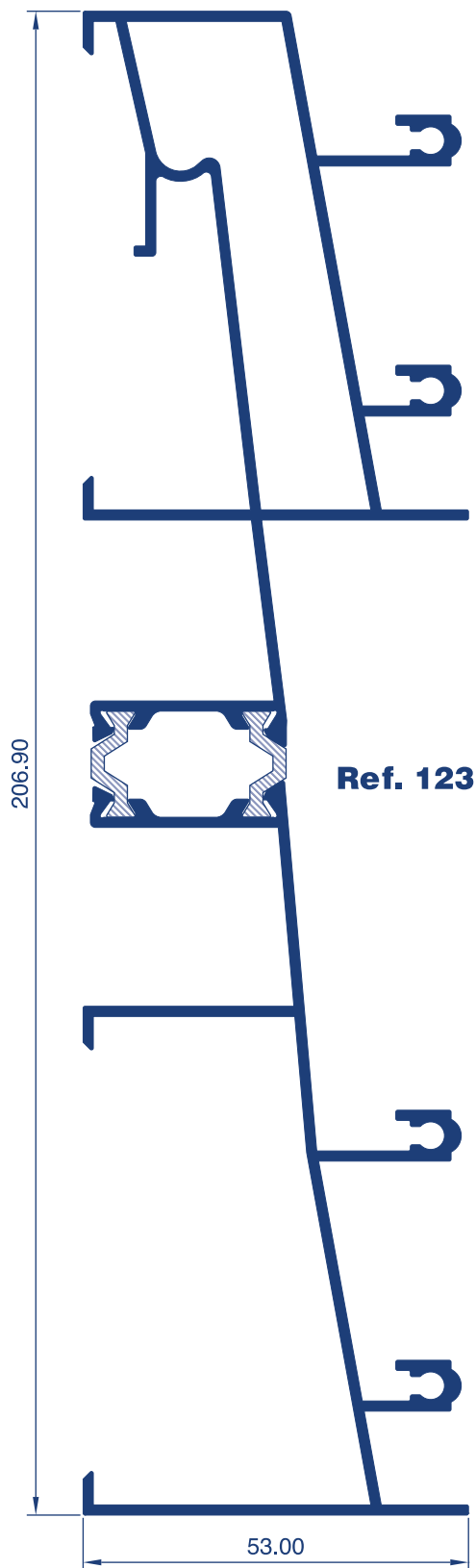

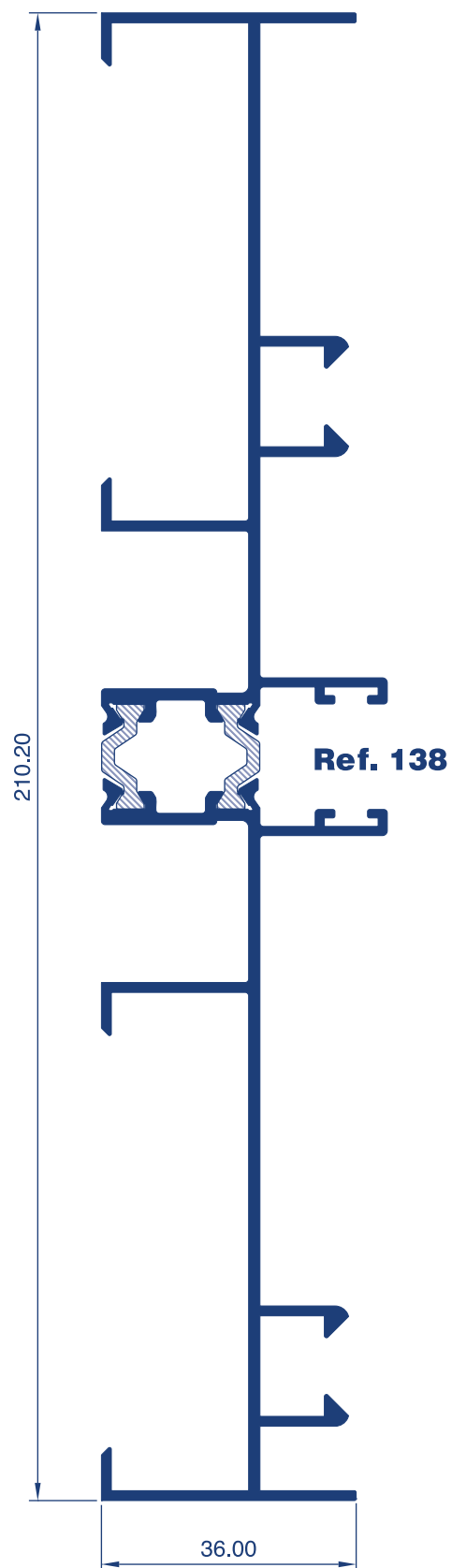
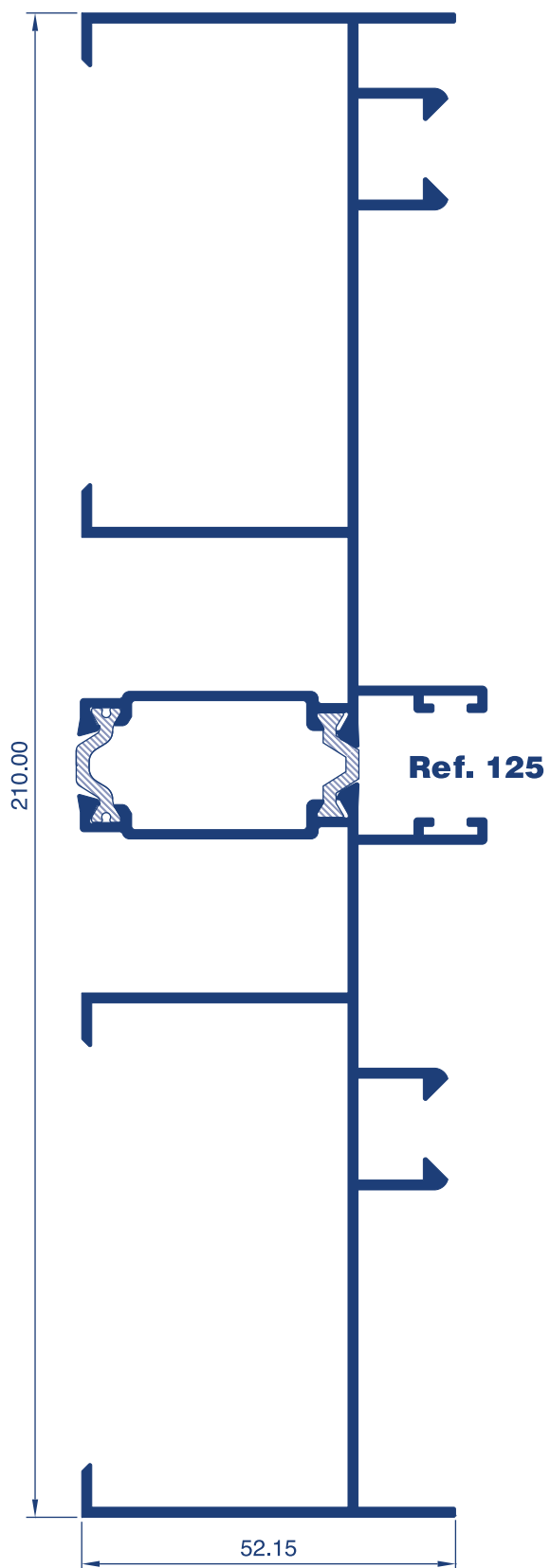



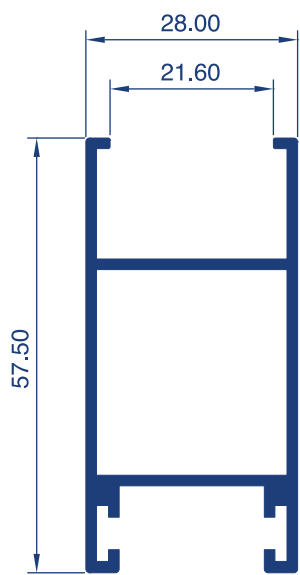

**Ref. 104**

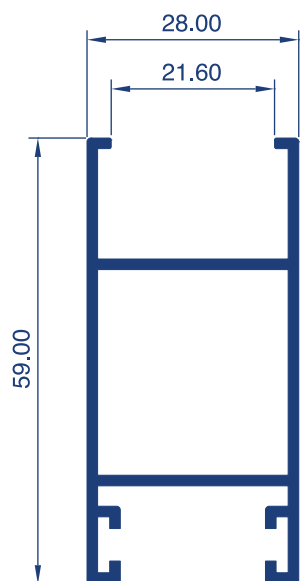

**Ref. 154**

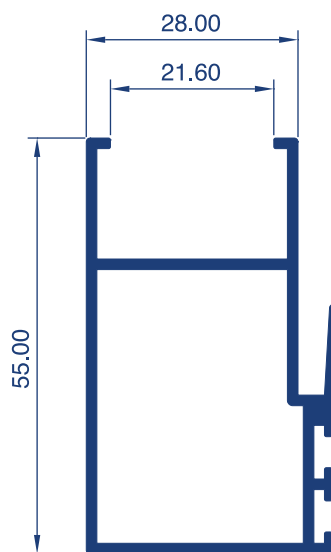

**Ref. 107**

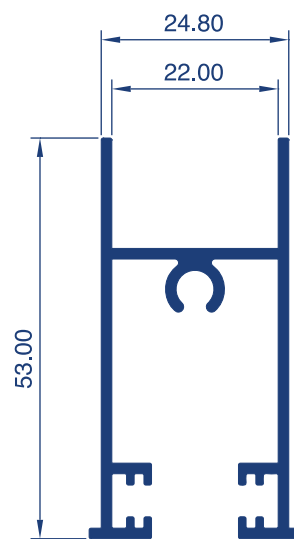

**Ref. 110**

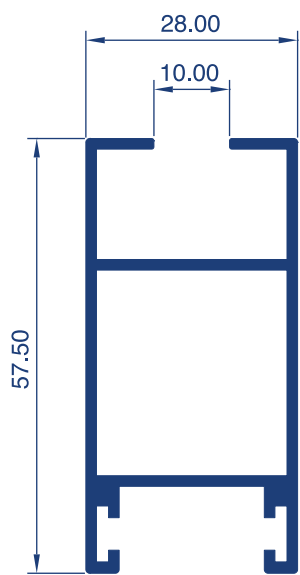

**Ref. 105**

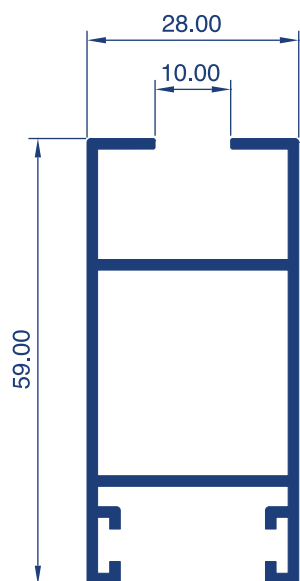

**Ref. 155**

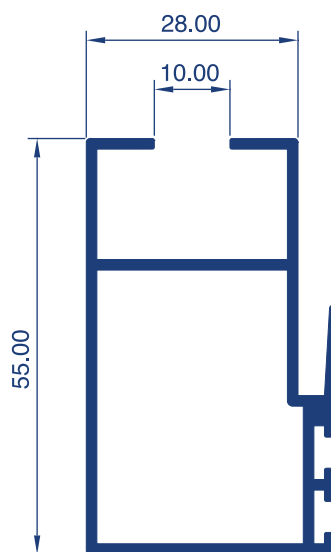

**Ref. 106**

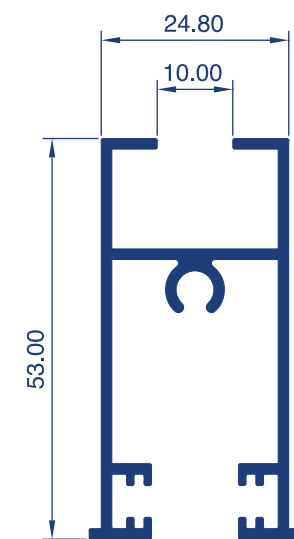

**Ref. 111**

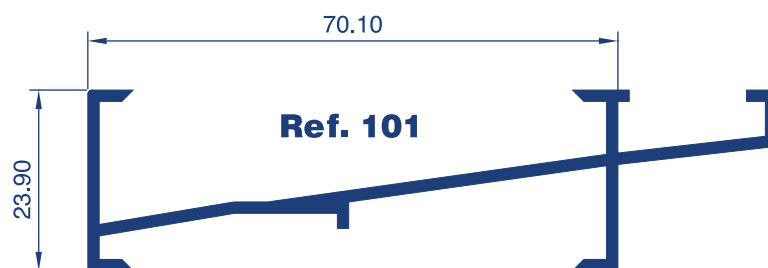
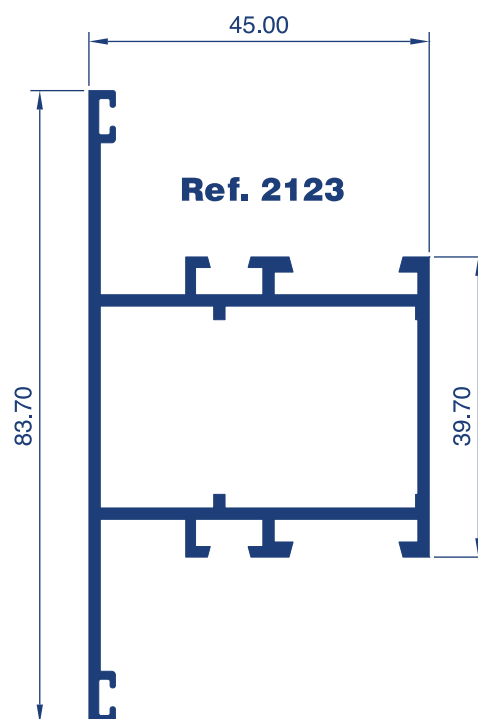
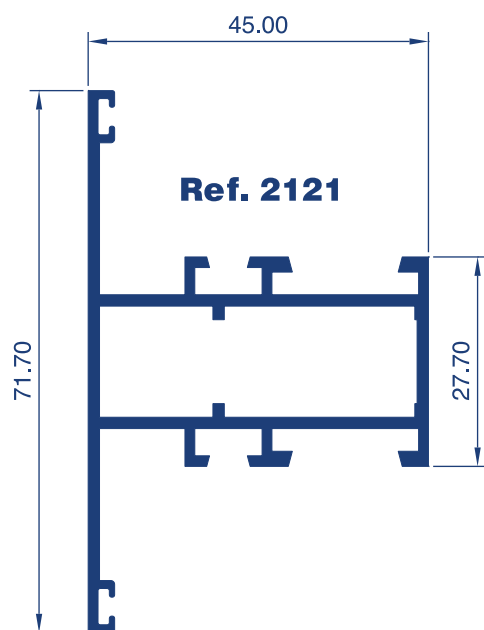

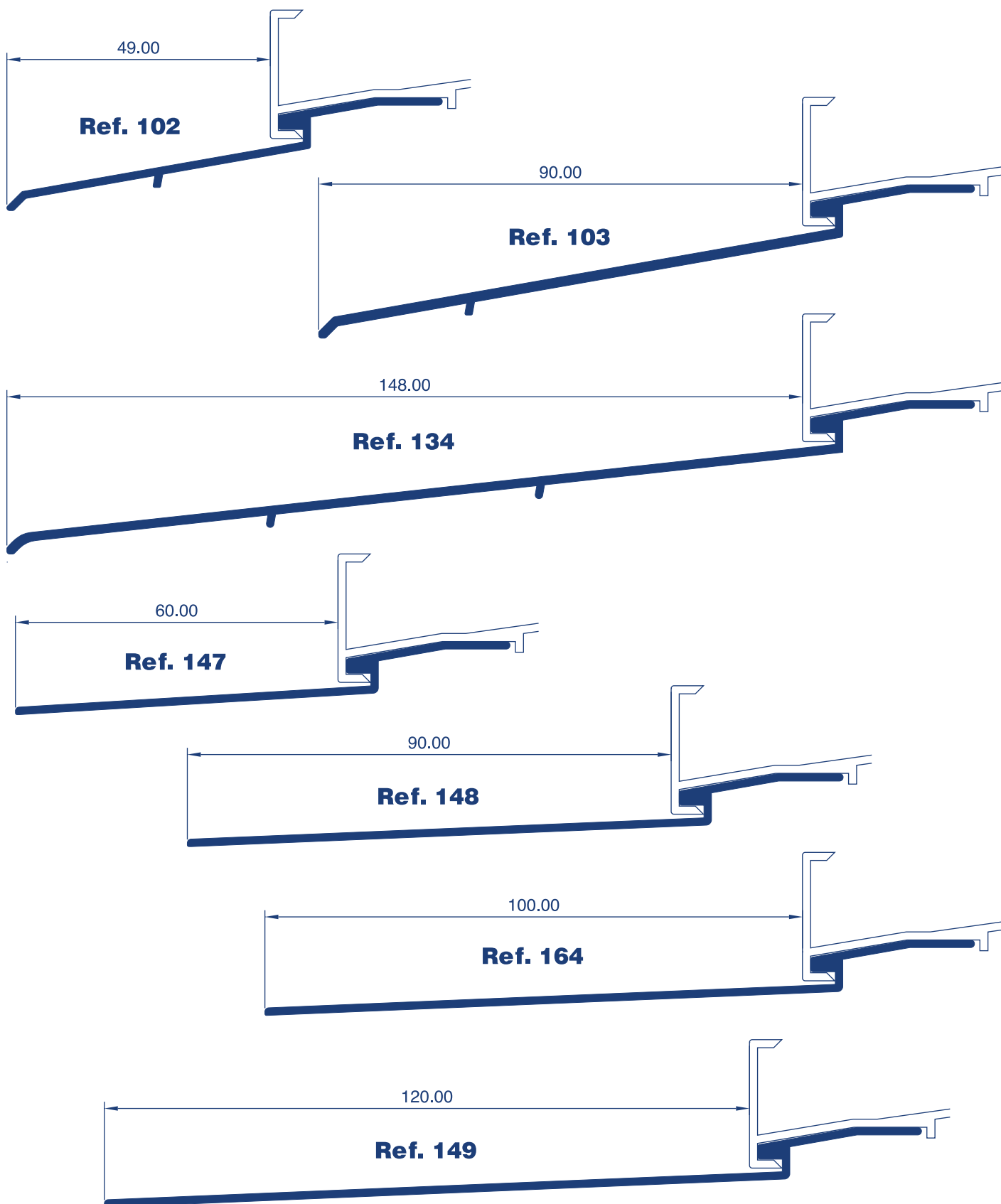

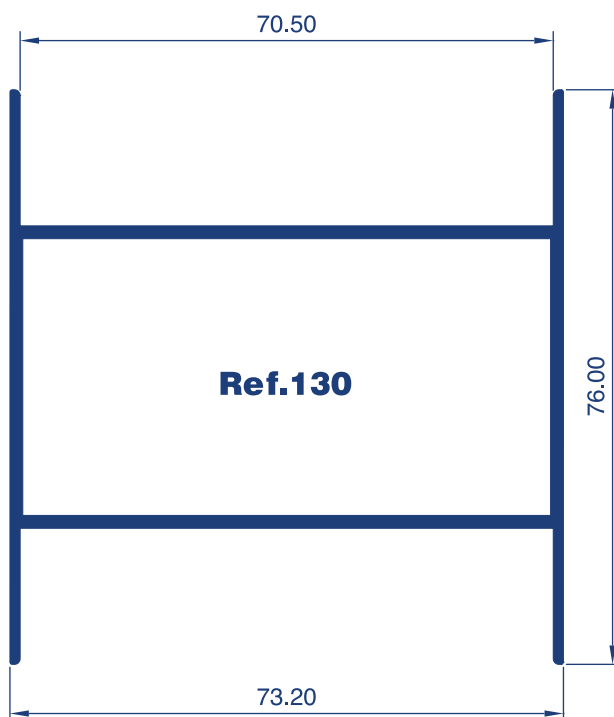
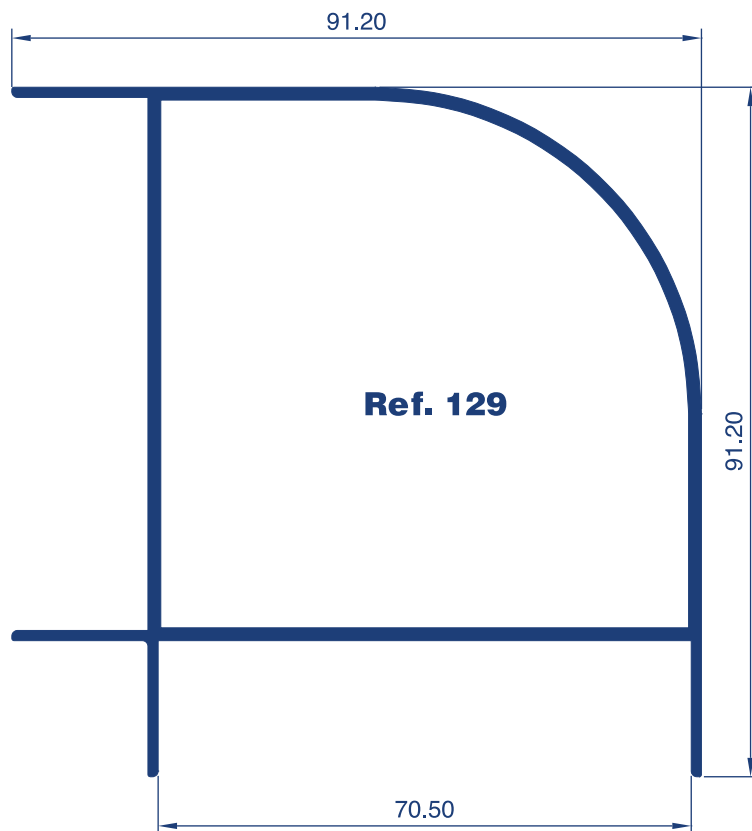

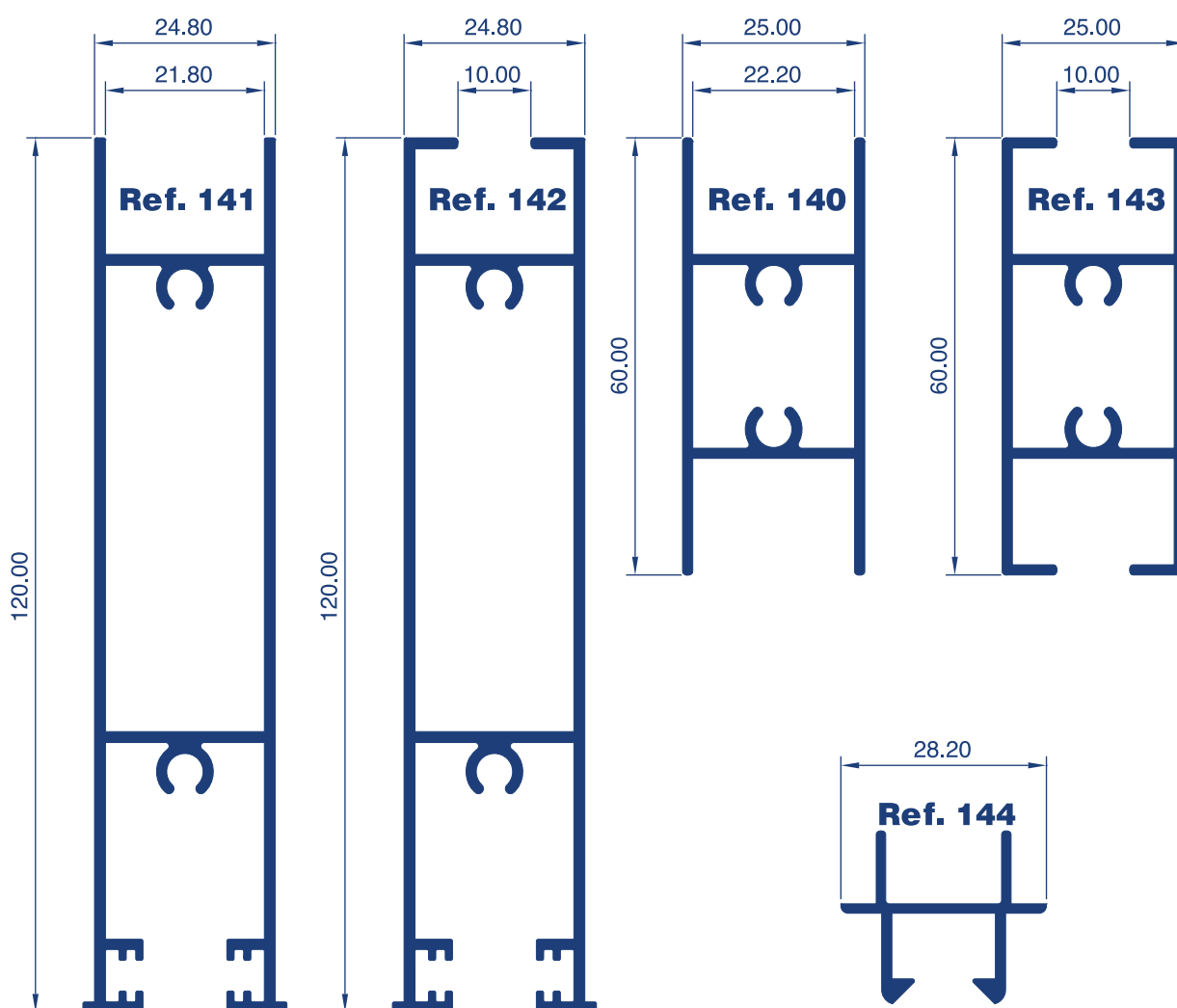

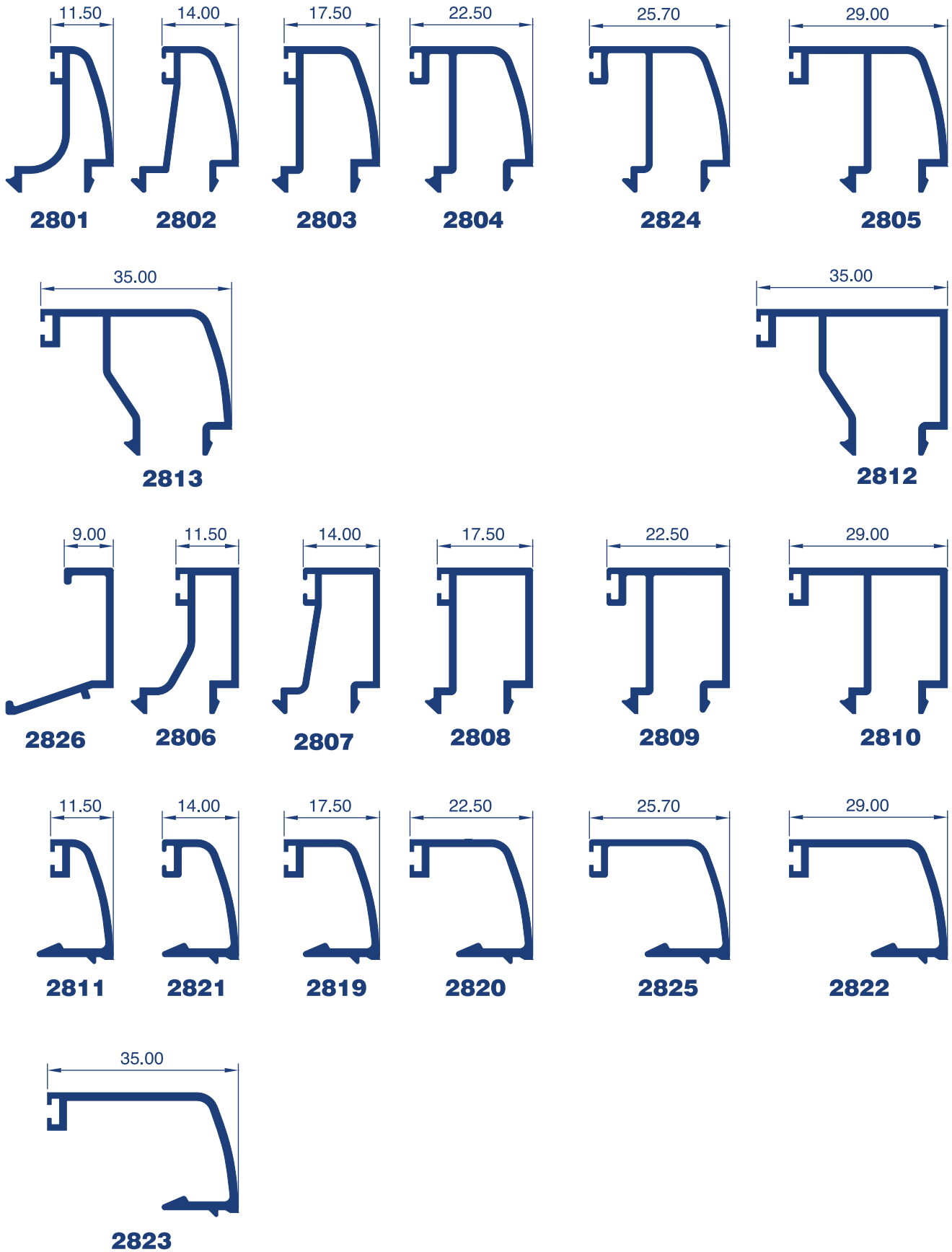

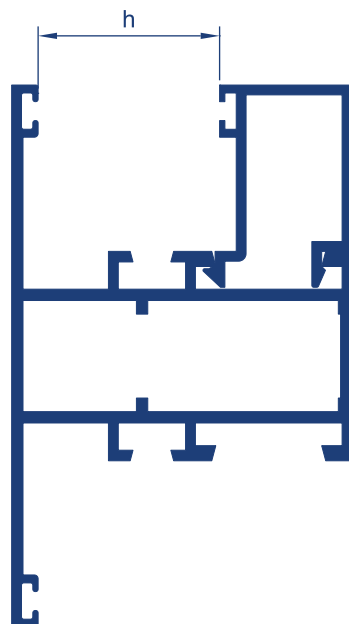

HUECOS LIBRES PARA ACRISTALAR

Junquillo		Hueco ( h )
recto	2826 (9mm)	30.5 mm
curvo	2801 (11.5mm)	29 mm
recto	2806 (11.5mm)	29 mm
curvo	2802 (14mm)	26.5 mm
recto	2807 (14mm)	26.5 mm
curvo	2803 (17.5mm)	23 mm
recto	2808 (17.5mm)	23 mm
curvo	2804 (22.5mm)	18 mm
recto	2809 (22.5mm)	18 mm
curvo	2824 (26mm)	14.5 mm
curvo	2805 (29mm)	11.5 mm
recto	2810 (29mm)	11.5 mm
curvo	2813 (35mm)	5.5 mm
recto	2812 (35mm)	5.5 mm

Junquillos grapa para junquillos curvos						
Junquillos curvos						
2801	2802	2803	2804	2805	2813	2824
2811	2821	2819	2820	2822	2823	2825
Junquillos grapa						

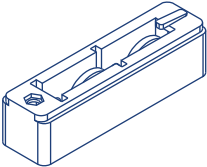
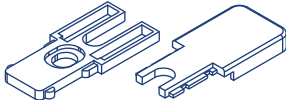
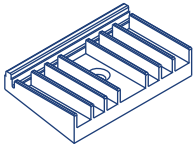
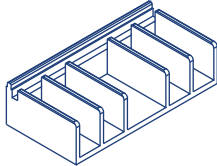
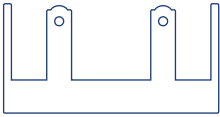
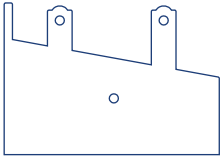
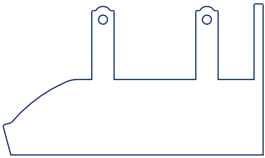
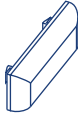
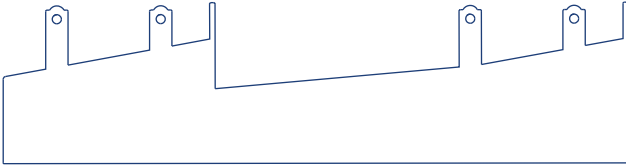
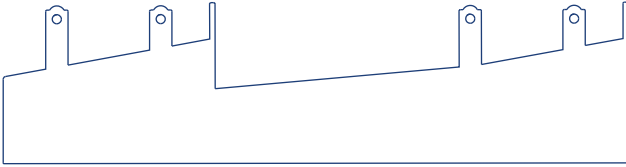
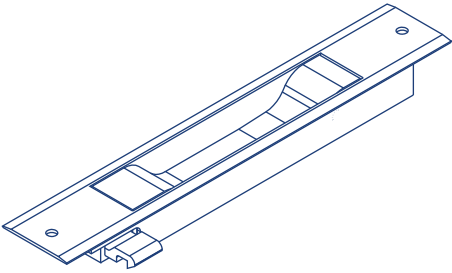
 x ud	<p>Ref. <b>30360</b></p> <p>Ruleta tandem 2 ruedas</p>	 x jgo	<p>Ref. <b>30210</b></p> <p>Tapeta lateral</p>
 x ud	<p>Ref. <b>30130</b></p> <p>Cortavientos inferior</p>	 x ud	<p>Ref. <b>30120</b></p> <p>Cortavientos superior</p>
 25uds / bolsa	<p>Ref. <b>30266</b></p> <p>Juego de juntas estanqueidad marco superior</p>	 25uds / bolsa	<p>Ref. <b>30267</b></p> <p>Juego de juntas estanqueidad marco inferior</p>
 25uds / bolsa	<p>Ref. <b>30275</b></p> <p>Juego de juntas estanqueidad marco superior doble ventana</p>	 x ud	<p>Ref. <b>30370</b></p> <p>Tapa desagüe negra</p>
 25uds / bolsa			<p>Ref. <b>30270</b></p> <p>Juego de juntas estanqueidad marco inferior doble ventana</p>
		<p>Ref. <b>30522</b></p> <p>Cierre de embutir negro</p> <p>Ref. <b>30539</b></p> <p>Cierre de embutir blanco</p>	
2uds / bolsa			



DOMO 70

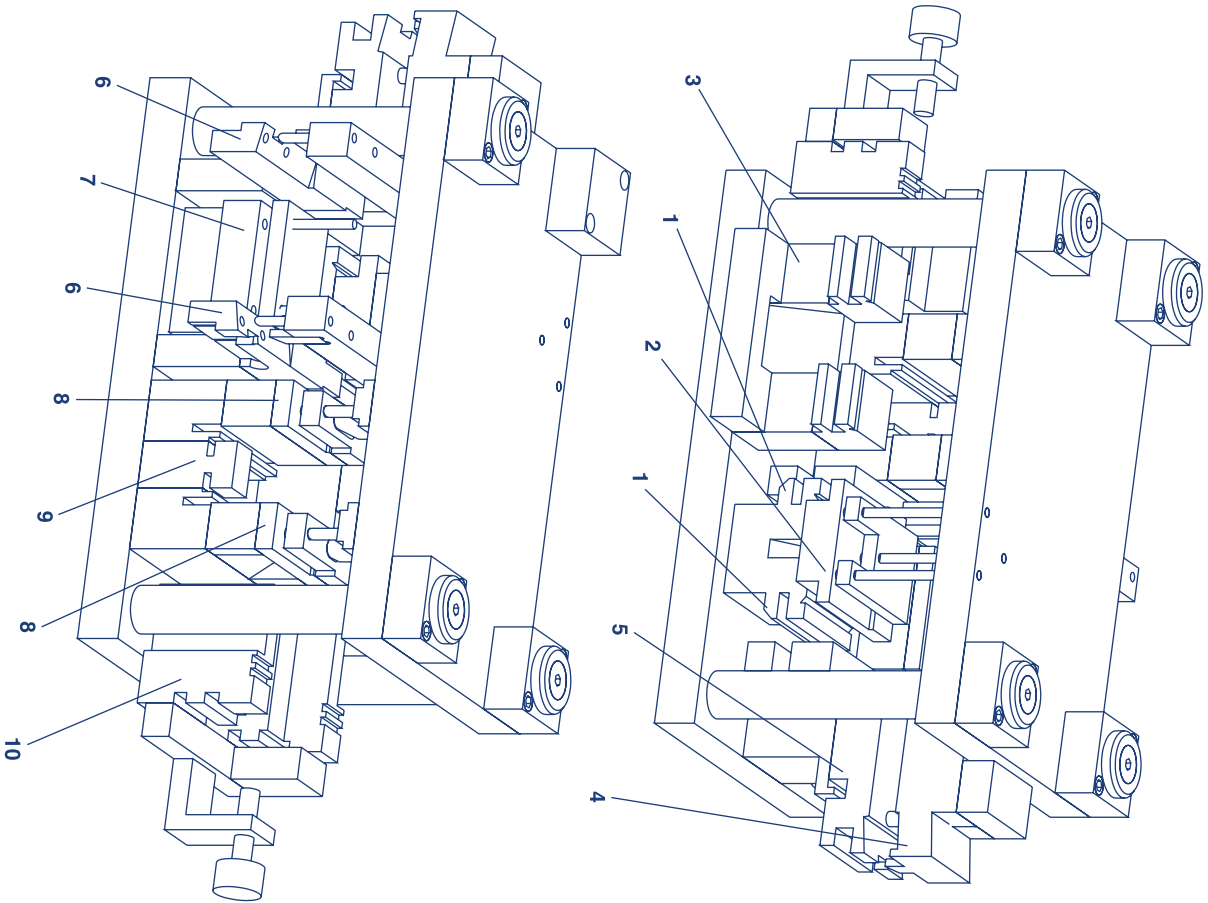

**POSICIONES DE MECANIZADO**

- 1.- MECANIZADO PESTAÑAS MARCO LATERAL PARA ACOPLE MARCO SUPERIOR E INFERIOR
- 2.- MECANIZADO TALADROS MARCO LATERAL
- 3.- MECANIZADO PESTAÑAS MARCO LATERAL PARA ACOPLE MARCO FIJO
- 4.- MECANIZADO SALIDA DE AGUAS CARRILES MARCO INFERIOR
- 5.- MECANIZADO SALIDA DE AGUAS CÁMARA MARCO INFERIOR
- 6.- MECANIZADO SALIDA DE AGUAS FRENTE CÁMARA MARCO INFERIOR
- 7.- MECANIZADO TALADROS MARCO FIJO
- 8.- MECANIZADO RANURA PARA CARRIL MARCOS SUPERIOR E INFERIOR Y TALADRO DE SUECCIÓN
- 9.- MECANIZADO PESTAÑAS Y TABIQUE CENTRAL HOJAS
- 10.- MECANIZADO MARCO FIJO PARA ACOPLE LATERALES Y ZANCA

POSICIONES 1, 2, 3

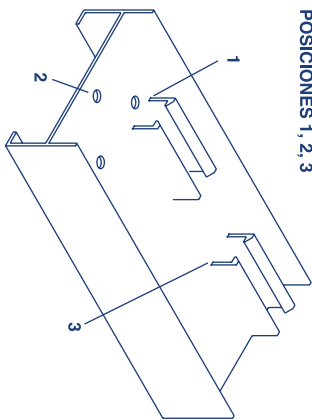

VENTANA DERECHA

VENTANA IZQUIERDA

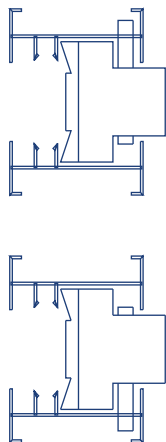

POSICIONES 4, 5

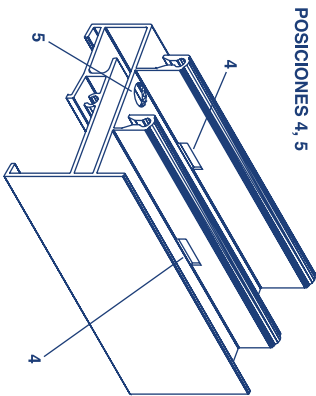

POSICIÓN 6

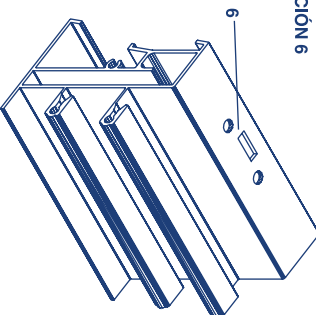

POSICIONES 8, 9

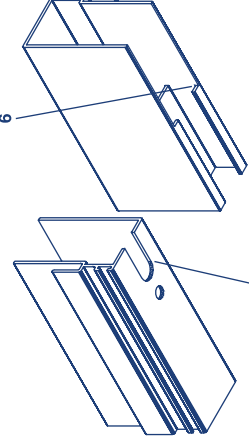

POSICIONES 7, 10

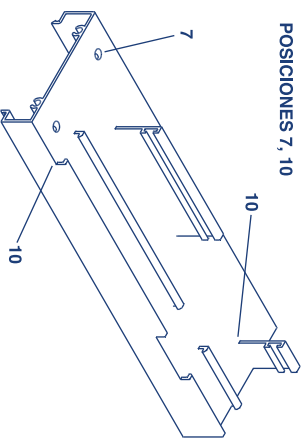

DOMO 70 MARCO CON GUÍA

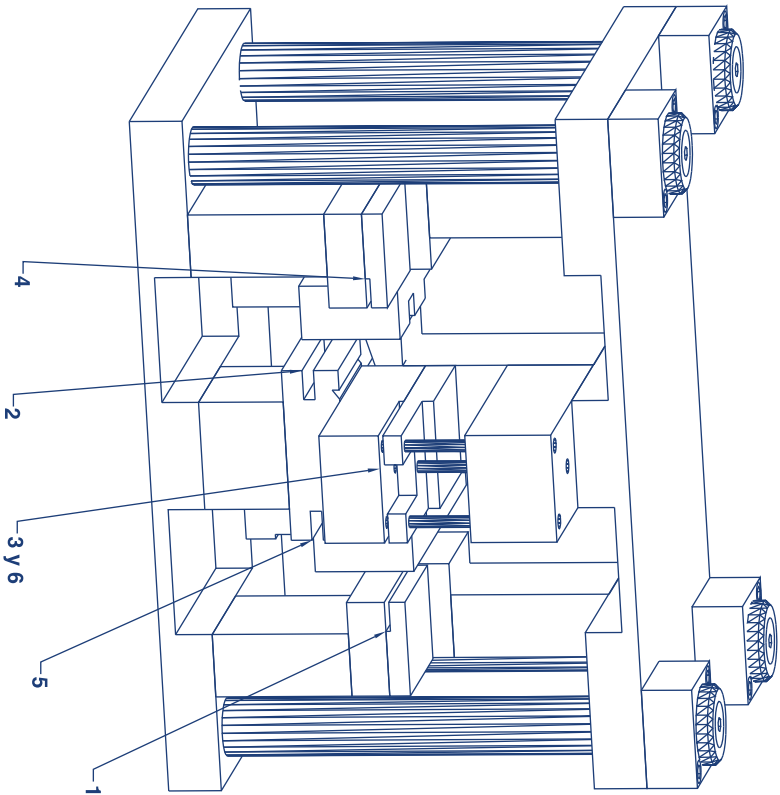

- POSICIONES DE MECANIZADO**
- 1.- MECANIZADO PESTAÑA LISA MARCO LATERAL PARA ACOPLE MARCO INFERIOR
  - 2.- MECANIZADO PESTAÑAS MARCO LATERAL PARA ACOPLE MARCO INFERIOR
  - 3.- MECANIZADO TALADROS MARCO LATERAL PARA ACOPLE MARCO INFERIOR
  - 4.- MECANIZADO PESTAÑA LISA (CON VARILLA) MARCO LATERAL PARA ACOPLE MARCO SUPERIOR
  - 5.- MECANIZADO PESTAÑAS (CON VARILLA) MARCO LATERAL PARA ACOPLE MARCO SUPERIOR
  - 6.- MECANIZADO TALADROS MARCO LATERAL PARA ACOPLE MARCO SUPERIOR (PARA MECANIZAR EL OTRO MARCO LATERAL LA SECUENCIA ES 4, 5, 3, 1, 2, 6)

MECANIZADO 1

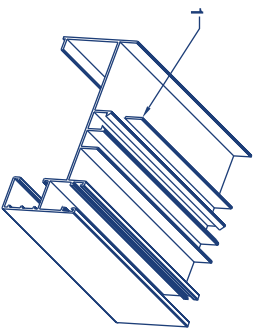

MECANIZADO 2

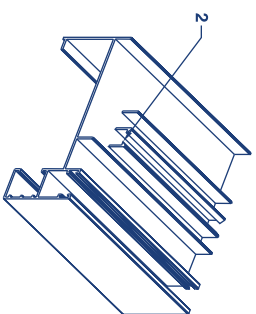

MECANIZADO 3

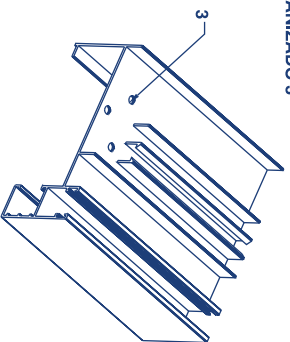

MECANIZADO 4

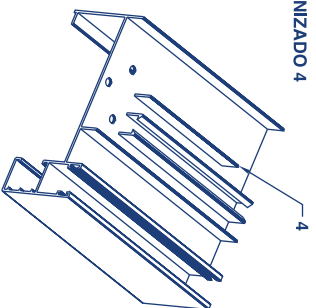

MECANIZADO 5

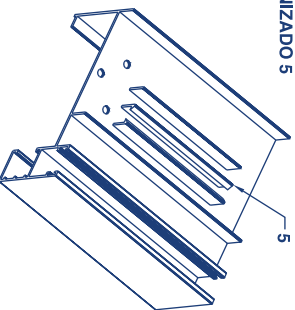

MECANIZADO 6

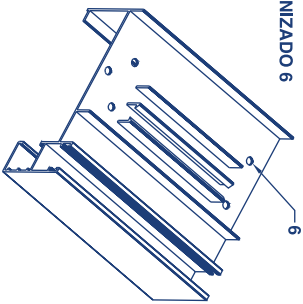

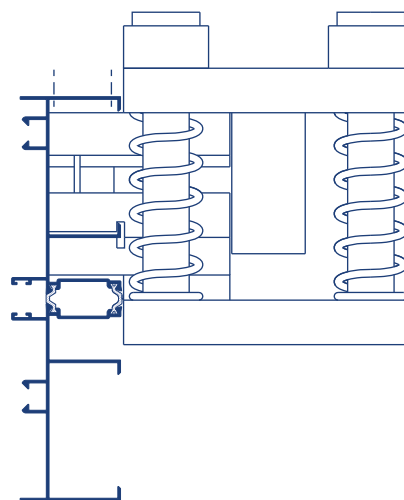
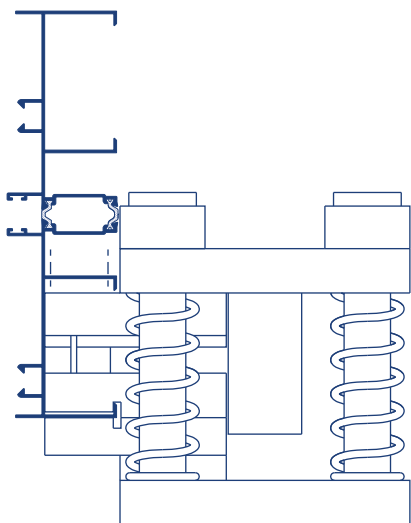
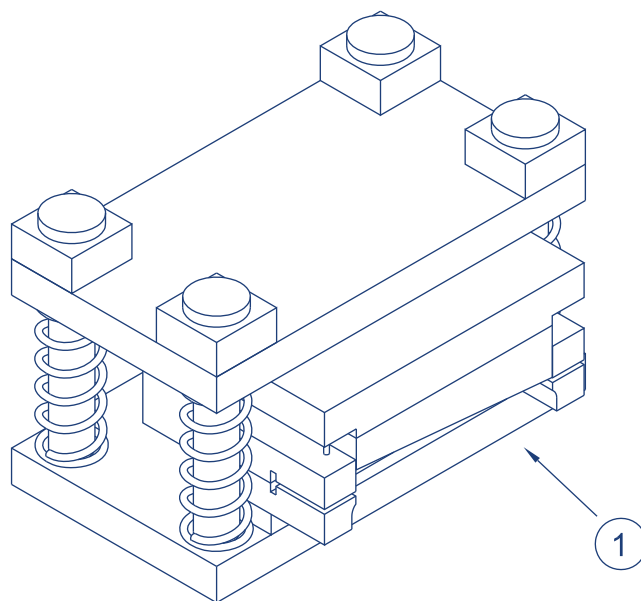

① Mecanizado de recogedor en marco lateral.

## Ventana 2 hojas

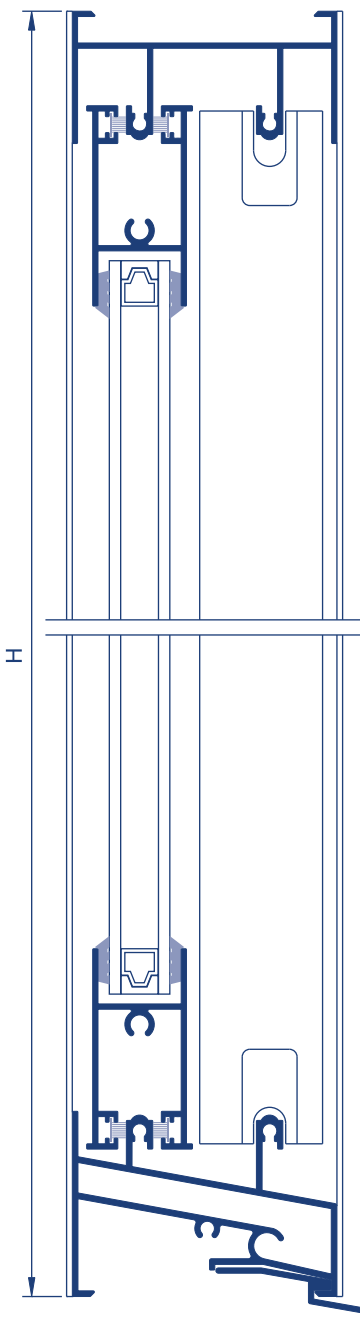
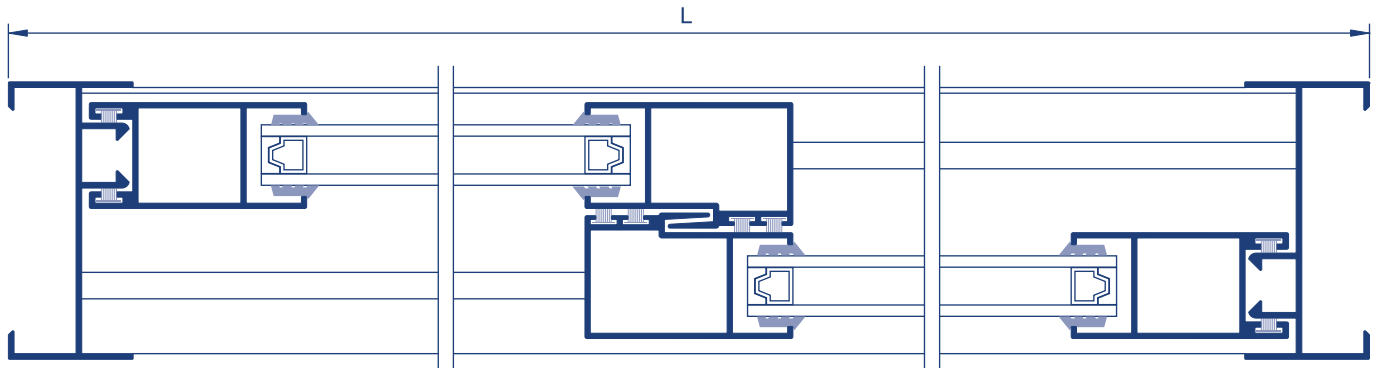





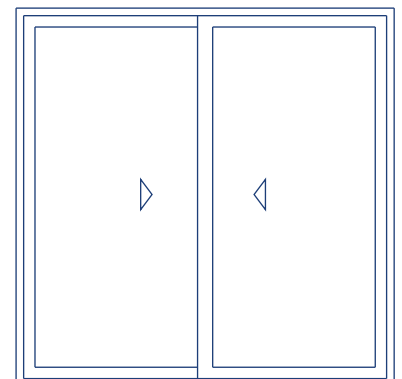



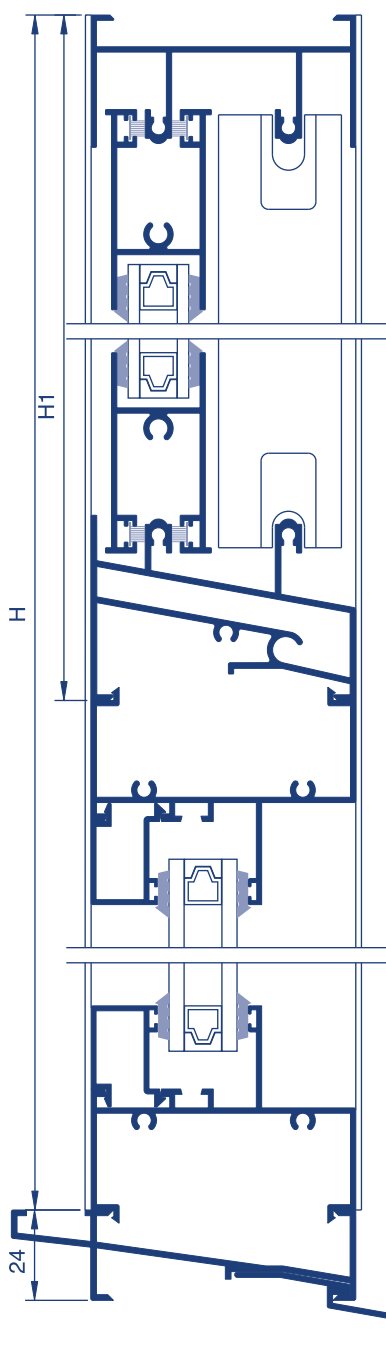
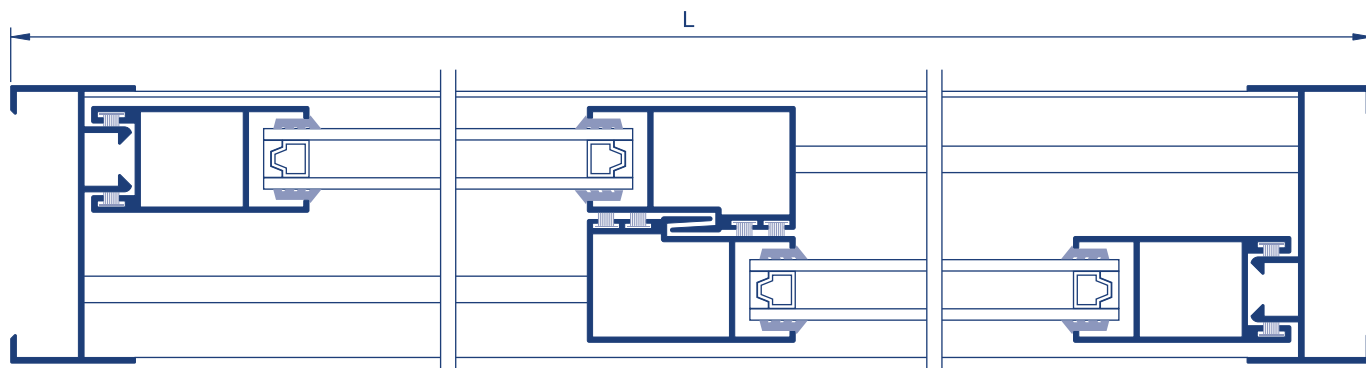



	Ref.	Descripción	Horizontal			Vertical		
			Corte	Cantidad	Medida	Corte	Cantidad	Medida
	114	Marco inferior		1	L - 39			
	113	Marco superior		1	L - 39			
	108	Marco lateral					2	H
	110	Hoja ruedas		4	L/2 - 9			
	104	Hoja lateral					2	H - 67
	107	Hoja centro					2	H - 67
	102	Alargadera		1	L			

Ref.	Descripción	Cantidad
30360	Rodamientos 2 ruedas	4
30210	Tapa lateral	4
30522	Cierre con cerradero	2
00000	Cepillo ( 7x5.5 ) Cepillo ( 7x5.5 )	8 L 6 H
30120	Cortavientos superior	1
30130	Cortavientos inferior	1
30266	Juego juntas estanqueidad marco superior	1
30267	Juego juntas estanqueidad marco inferior	1
30370	Tapa desagüe	2



Ventana 2 hojas con fijo inferior







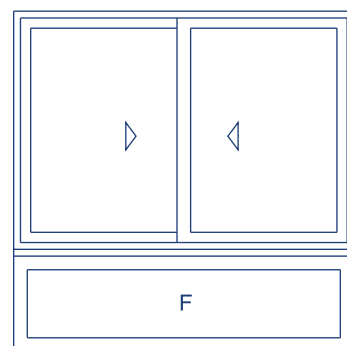



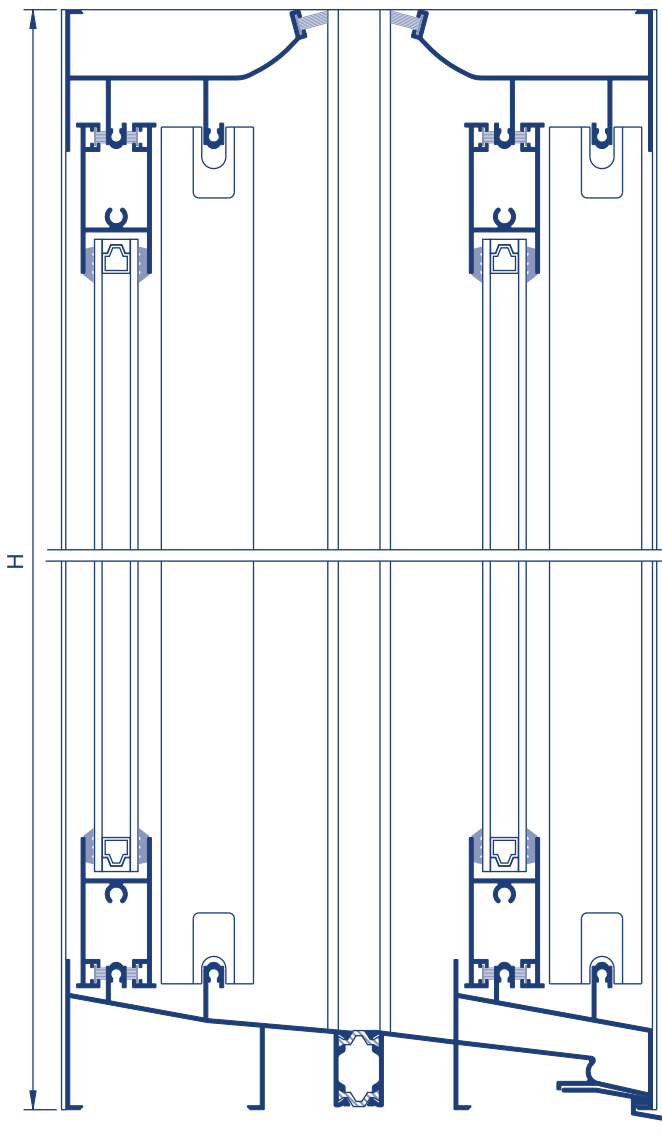
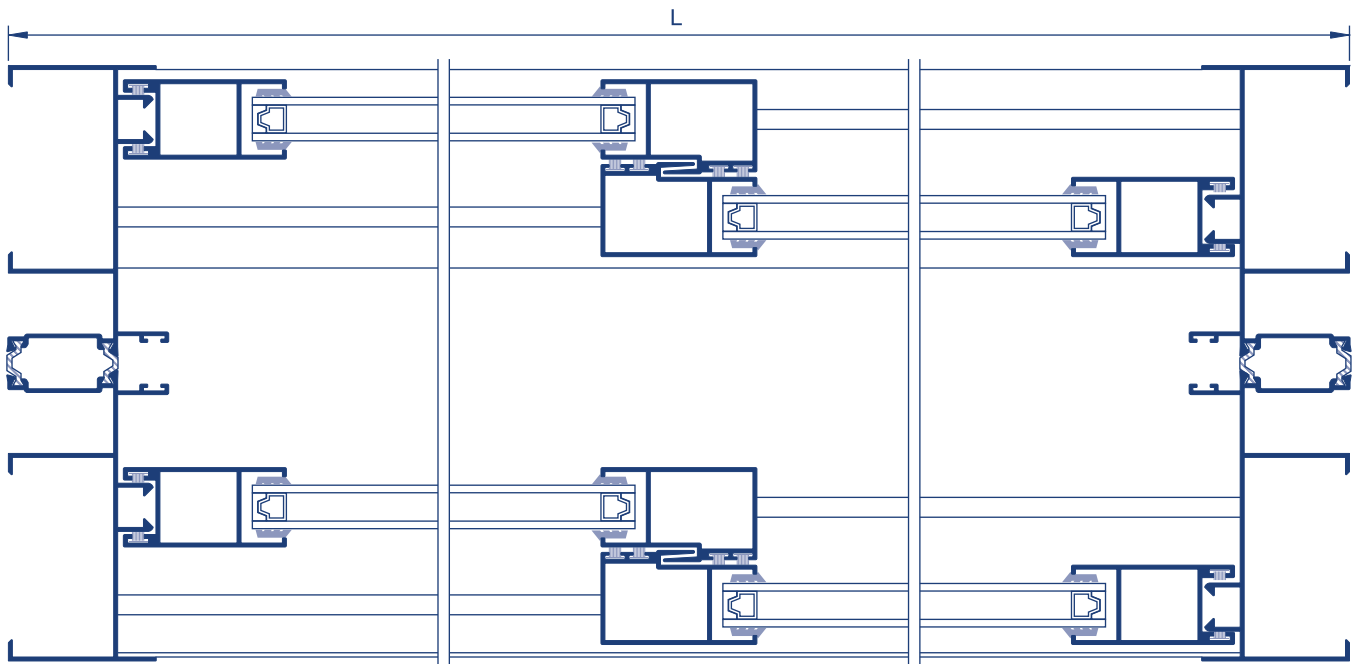





	Ref.	Descripción	Horizontal			Vertical		
			Corte	Cantidad	Medida	Corte	Cantidad	Medida
	114	Marco inferior		1	L - 39			
	113	Marco superior		1	L - 39			
	108	Marco lateral					2	H
	110	Hoja ruedas		4	L/2 - 9			
	104	Hoja lateral					2	H1 - 67
	107	Hoja centro					2	H1 - 67
	132	Marco fijo		2	L - 100		2	H - H1
	101	Condensación marco fijo		1	L			
		Junquillo		2	L - 110		2	(H - H1)-108
	102	Alargadera		1	L			

Ref.	Descripción	Cantidad
30360	Rodamientos 2 ruedas	4
30210	Tapa lateral	4
30522	Cierre con cerradero	2
00000	Cepillo ( 7x5.5 )	8 L
	Cepillo ( 7x5.5 )	6 H
30120	Cortavientos superior	1
30130	Cortavientos inferior	1
30266	Juego juntas estanqueidad marco superior	1
30267	Juego juntas estanqueidad marco inferior	1
30370	Tapa desagüe	2



## Doble ventana 2 hojas









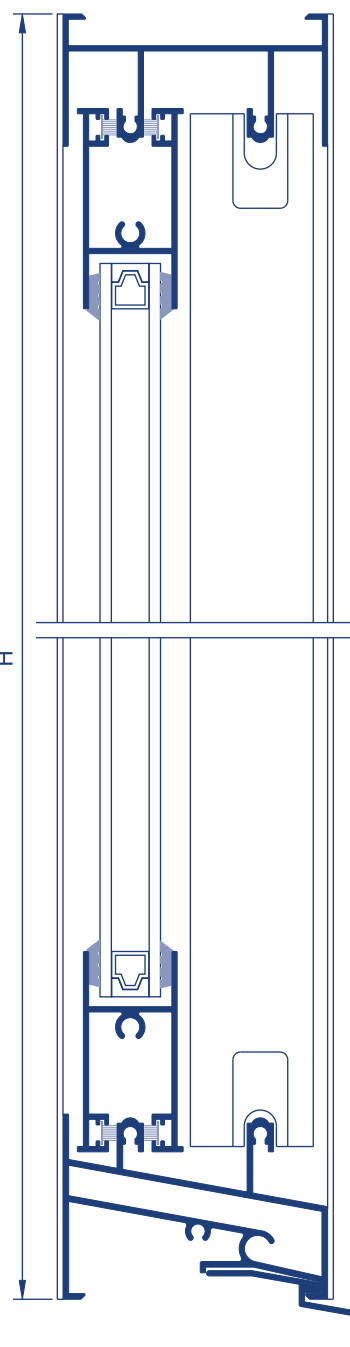
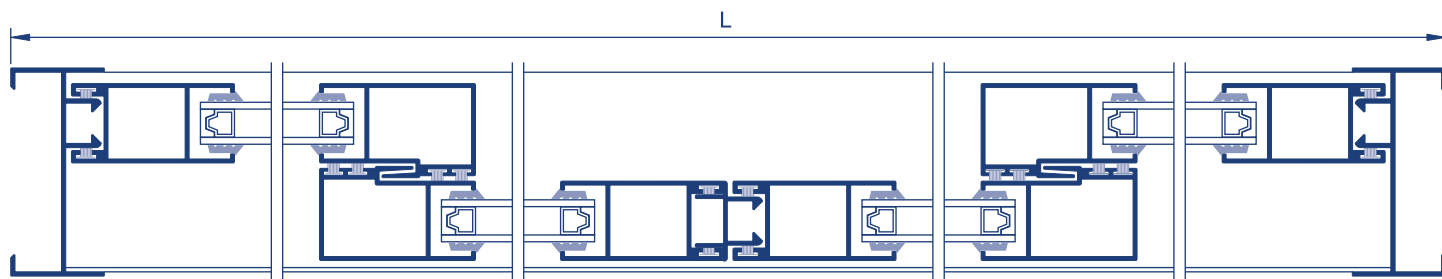









	Ref.	Descripción			
			Corte	Cantidad	Medida
	123	Marco inferior		1	L - 78
	117	Marco superior		2	L - 78
	125	Marco lateral		2	H
	110	Hoja ruedas		8	L/2 - 28
	104	Hoja lateral		4	H - 87
	107	Hoja centro		4	H - 87
	102	Alargadera		1	L

Ref.	Descripción	Cantidad
30360	Rodamientos 2 ruedas	8
30210	Tapa lateral	8
30522	Cierre con cerradero	2
00000	Cepillo ( 7x5.5 ) Cepillo ( 7x5.5 )	16 L/2 12 H
30120	Cortavientos superior	1
30130	Cortavientos inferior	1
30275	Juego juntas estanqueidad marco sup.	1
30270	Juego juntas estanqueidad marco inf.	1
30370	Tapa desagüe	2

### Ventana 4 hojas



	Ref.	Descripción	Horizontal			Vertical		
			Corte	Cantidad	Medida	Corte	Cantidad	Medida
	114	Marco inferior		1	L - 39			
	113	Marco superior		1	L - 39			
	108	Marco lateral					2	H
	110	Hoja ruedas		8	L/4 + 2			
	104	Hoja lateral					4	H - 67
	107	Hoja centro					4	H - 67
	144	Unión de 4 hojas					1	H - 67
	102	Alargadera		1	L			

Ref.	Descripción	Cantidad
30360	Rodamientos 2 ruedas	8
30210	Tapa lateral	8
30522	Cierre con cerradero	3
00000	Cepillo ( 7x5.5 ) Cepillo ( 7x5.5 )	16 L/4 10 H
30120	Cortavientos superior	2
30130	Cortavientos inferior	2
30266	Juego juntas estanqueidad marco super.	1
30267	Juego juntas estanqueidad marco infer.	1
30370	Tapa desagüe	4

